

# ICX

*The FAIR Implant-System*

## ICX-multi<sup>®</sup> CONCEPT MANUAL 1.0

**4-ON-ICX (MANDIBLE)**  
**3 to 8 unit implant supported bridges**  
**and whole jaw solutions**  
**6-ON-ICX (MAXILLA)**



# ICX-multi<sup>®</sup> CONCEPT

## MANUAL 1.0

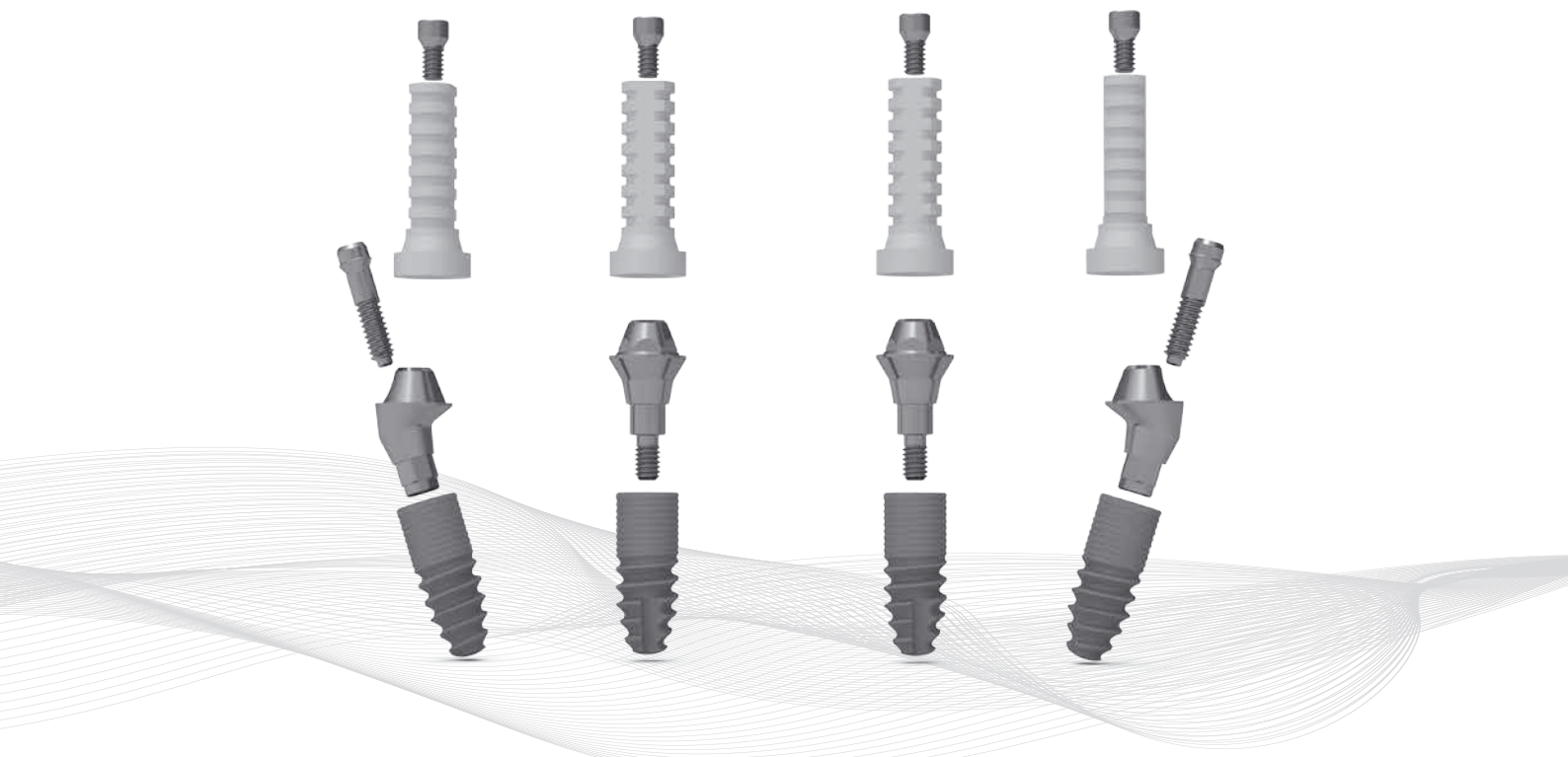

**4-ON-ICX (MANDIBLE)**  
**3 to 8 unit implant supported bridges**  
**and whole jaw solutions**  
**6-ON-ICX (MAXILLA)**

**medentis<sup>®</sup>**  
medical

# Content

## **The ICX-multi®-Concept**

What does the ICX-multi® system stand for  
and what possible applications does it offer ..... 4-7

## **Practical steps for use of ICX-multi® abutments**

Angled ICX-multi® abutments ..... 8

Straight ICX-multi® abutments ..... 9

## **Prosthetic solutions**

Closed and open tray impression ..... 10-11

ICX-CAD/CAM ..... 11

ICX-Maximus® ..... 12

ICX-multi® bonded abutments ..... 13

## **Overview**

ICX-multi® products ..... 14-16

**Order in our ICX shop online at:  
[www.medentis.de](http://www.medentis.de)**

# ICX

*The FAIR Implant-System*



# The ICX-multi® Concept: 4-on-ICX and 6-on-ICX

Following the ICX-multi® Concept will enable you to successfully rehabilitate the edentulous patient without the need for bone reconstruction at a reasonable cost.

Procedures can be carried out with or without the use of a navigation software and depending on bone quality and quantity even immediate loading is possible.

For many patients, this can bring the fixed solution they have been dreaming about within financial reach. The fair pricing of our ICX premium implants contributes largely to this.



## ICX-multi® – Firm teeth for happy patients.

### Implant supported bridge in the mandible (4 on ICX) following the ICX-multi® Concept

- No decementation or loosening of the distal abutments due to the prosthetics being outside the torsion zone of the mandible
- Four implants placed (interforaminal placement - no need for additional measures to relocate the ID canal)
- Restored with fixed bridgework (avoiding removable prosthetics)
- Reduced cost.

### 4-ON-ICX (MANDIBLE)

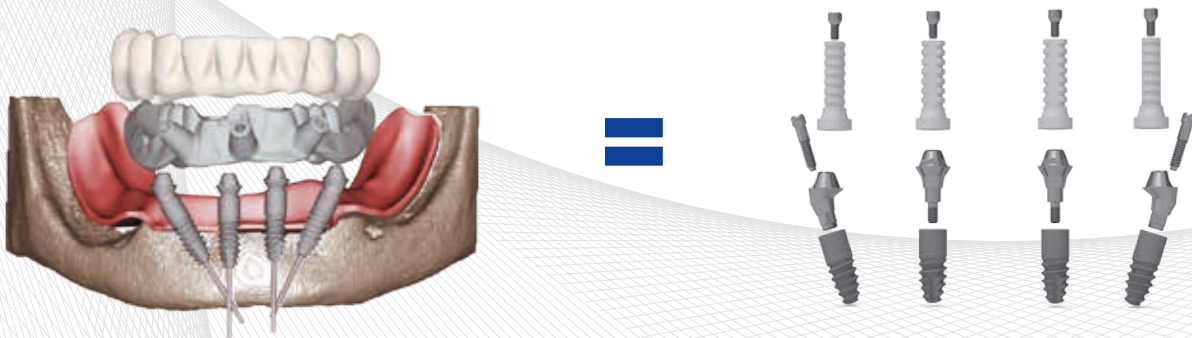

### Implant supported bridge in the maxilla (6 on ICX) following the ICX-multi® Concept

- Six implants (horseshoe design - leaving the palate uncovered)
- Avoiding sinus lift
- Reduced treatment time
- Reduced cost

### 6-ON-ICX (MAXILLA)

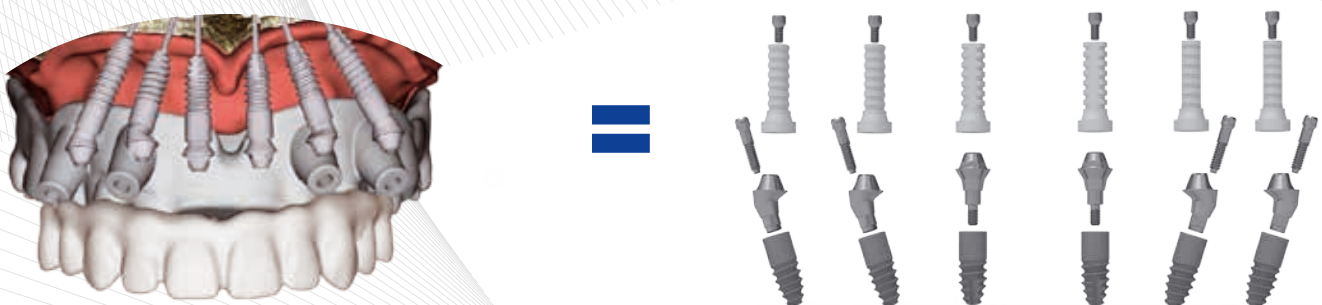

# The ICX-multi® Concept: 4-on-ICX and 6-on-ICX

Utilising clever design features, we could reduce the minimal height from 9.7mm to 5.5mm.

Different gingival heights are available.

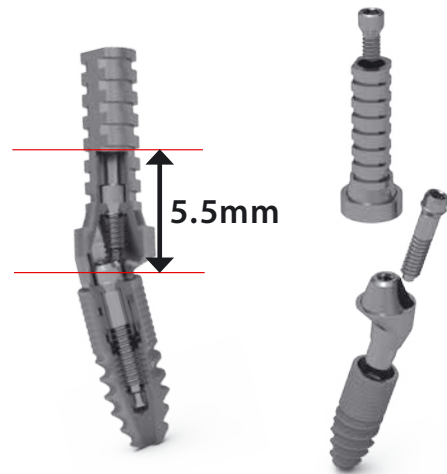

Easy transfer with customised holder.

Holder doubles as reference for parallelism.

(see picture:

ICX-multi® with holder/parallelism reference)



## Design with ICX-denta5

CAD/CAM connection offers a variety of prosthetic options. By using the ICX-denta5 service for your prosthetics or design them yourself thanks to the possibilities offered by CAD/CAM.

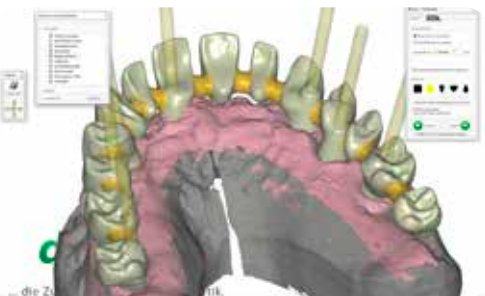

Via the ICX-multi® Concept you also have the option to correct diverging angles of abutments for the use of LOCATOR™/Maximus® connectors.



# The ICX-multi® Concept: 4-on-ICX and 6-on-ICX

**ICX-multi® abutment,  
35°**

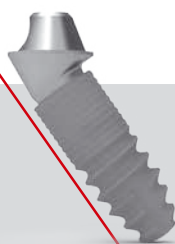

**ICX-multi® abutment,  
17°**



**ICX-multi® abutment  
straight**



The angulation can be exactly pre-determined by case-planning in the ICX-MAGELLAN software.



**medentis**  
medical

# ICX-multi<sup>®</sup> CONCEPT

**4-ON-ICX (MANDIBLE)**  
**3 to 8 unit implant supported bridges**  
**and whole jaw solutions**  
**6-ON-ICX (MAXILLA)**



**Order in our ICX shop online at:**  
**[www.medentis.de](http://www.medentis.de)**

# The ICX-multi® Concept:

## Practical steps for use of ICX-multi® abutments

### ANGLED ICX-multi® ABUTMENTS



1  
The abutment is delivered in a blister pack. A parallelism reference tool is included in the pack.



2  
Angulated ICX-multi abutments have to be assembled with a 1.2 screw driver. The screw canal is axial.



3  
The parallelism reference tool is connected to the occlusal thread.

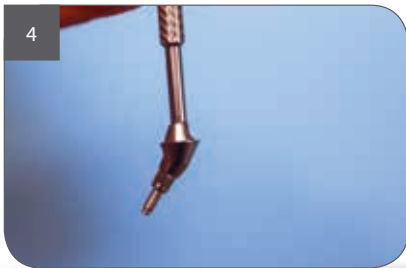

4  
The ICX-multi abutment ready for connection to the implant.



5  
The ICX-multi abutment can be connected to the implant in the optimum angulation/parallel to the other ICX-multi abutments thanks to the parallelism reference tool.



6  
Angulated ICX-multi abutments are tightened to the implants with a 1.2 screw driver.



7  
The connection screw is tightened to 30Ncm.



8  
As soon as two or more parallelism reference tools are connected to the abutments, it is possible to check and correct parallelism of the abutments.



**medentis**  
medical



# The ICX-multi® Concept: Practical steps for use of ICX-multi® abutments

## STRAIGHT ICX-multi® ABUTMENTS



1 The abutment is delivered in a blister pack. A carrier is included in the pack. The abutment is inserted into the carrier.



2 The straight abutment is placed onto the implant and tightened with the provided carrier.



3 After the abutment is placed finger tight, the carrier can be removed with an audible 'click'.



4 The abutment is further tightened with the ICX-multi tool for straight abutments.



5 The screw is tightened to a torque of 30Ncm.



6 As soon as two or more parallelism reference tools are connected to the abutments, it is possible to check and correct parallelism of the abutments.

# ICX

The FAIR Implant-System

**Order in our ICX shop online at:  
[www.medentis.de](http://www.medentis.de)**

# The ICX-multi® Concept: Prosthetic solutions

## CLOSED TRAY IMPRESSION



1  
The blister pack contains an ICX-multi impression post and an impression cap.



2  
The impression post is placed onto the ICX-multi abutment.



3  
The impression post is then tightened finger tight.



4  
Ensure correct orientation of the impression cap when placing on the impression post. The flat surfaces must match.



5  
Correct seating of the impression cap on the impression post will be confirmed by an audible 'click'. The impression can now be taken.



**medentis**<sup>®</sup>  
medical

**Order in our ICX shop online at:  
[www.medentis.de](http://www.medentis.de)**

# The ICX-multi® Concept: Prosthetic solutions

## OPEN TRAY IMPRESSION



1  
The blister pack contains the ICX-multi impression post with screw and a screw canal protector cap.



2  
The ICX-multi impression post has its own screw which has to be tightened with a 1.2 screw driver.



3  
The impression post is placed onto the ICX-multi abutment.



4  
The impression post is tightened finger tight.

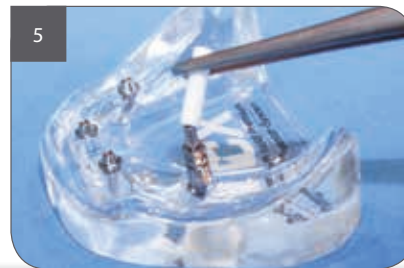

5  
The screw canal protector cap is placed onto the impression post as a protection from impression material.



## ICX-multi® CAD/CAM



1  
The scan abutment is delivered in a blister pack.



2  
The scan abutment is placed onto the ICX-multi abutment.

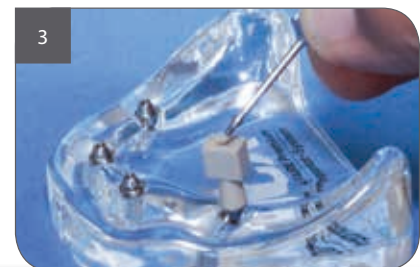

3  
The scan abutment is tightened.

# The ICX-multi® Concept: Prosthetic solutions

A large variety of options is available for the prosthetic restoration of ICX-multi abutments.

## Please note:

Overdentures with telescopic connectors **are not compatible** with ICX-multi® abutments.

## ICX-MAXIMUS®



1  
The ICX-Maximus cap is delivered in a blister pack.



2  
The ICX-Maximus cap is screwed directly onto the ICX-multi abutment.



3  
4  
The ICX-multi abutment is ready for insertion.



5  
The screw on the abutment is tightened to a torque of 27Ncm.



6  
7  
The use of ICX-multi abutment provides the option of angulating the LOCATOR™/Maximus® connectors.

# The ICX-multi® Concept: Prosthetic solutions

## ICX-multi® BONDED ABUTMENTS



1  
The abutment is delivered in a blister pack.



2  
There are special occlusal screws for the ICX-multi abutment prosthetics. For this, the hexagonal SW 1.2mm is required.



3  
The bonded abutment is placed onto the ICX-multi abutment.



4  
Tightening of the abutment.



5  
The screw on the abutment is torqued to 27Ncm.



6  
The use of the bonded abutment provides several options for the prosthetic restoration.



7  
Screw retained bridges made from various materials.







8  
Bar retained prosthetics.

**medentis**  
medical

# Overview: The ICX-multi® products

**Only for bar, bridge or fused crowns –  
Not suitable for single tooth restorations or copings.  
Required height 5.5mm, screwdriver SW 1.2mm**

Article-Nr.		Article	Dimensions	Material	Price €
C-020-751705		<b>17° ICX-multi</b> Abutment, GH 0.5mm <b>with hex</b>	GH 0.5mm K 2.2mm	Titanium	<b>99*</b>
C-020-751715		<b>17° ICX-multi</b> Abutment, GH 1.5mm <b>with hex</b>	GH 1.5mm K 2.2mm	Titanium	<b>99*</b>
C-020-751735		<b>17° ICX-multi</b> Abutment, GH 3.5mm <b>with hex</b>	GH 3.5mm K 2.2mm	Titanium	<b>99*</b>
C-020-753505		<b>35° ICX-multi</b> Abutment, GH 0.5mm <b>with hex</b>	GH 0.5mm K 2.2mm	Titanium	<b>99*</b>
C-020-753515		<b>35° ICX-multi v,</b> GH 1.5mm <b>with hex</b>	GH 1.5mm K 2.2mm	Titanium	<b>99*</b>
C-020-753535		<b>35° ICX-multi</b> Abutment, GH 3.5mm <b>with hex</b>	GH 3.5mm K 2.2mm	Titanium	<b>99*</b>
C-020-851705		<b>17° ICX-multi</b> Abutment, GH 0.5mm <b>non hex</b>	GH 0.5mm K 2.2mm	Titanium	<b>99*</b>
C-020-851715		<b>17° ICX-multi</b> Abutment, GH 1.5mm <b>non hex</b>	GH 1.5mm K 2.2mm	Titanium	<b>99*</b>
C-020-851735		<b>17° ICX-multi</b> Abutment, GH 3.5mm <b>non hex</b>	GH 3.5mm K 2.2mm	Titanium	<b>99*</b>
C-020-853505		<b>35° ICX-multi</b> Abutment, GH 0.5mm <b>non hex</b>	GH 0.5mm K 2.2mm	Titanium	<b>99*</b>
C-020-853515		<b>35° ICX-multi</b> Abutment, GH 1.5mm <b>non hex</b>	GH 1.5mm K 2.2mm	Titanium	<b>99*</b>
C-020-853535		<b>35° ICX-multi</b> Abutment, GH 3.5mm <b>non hex</b> anti-rotation lock	GH 3.5mm K 2.2mm	Titanium	99*
C-020-750010		ICX-multi Abutment, straight, one piece GH 1mm	GH 1mm K 2.2mm	Titanium	<b>39*</b>
C-020-750020		ICX-multi Abutment, straight, one piece GH 2mm	GH 2mm K 2.2mm	Titanium	<b>39*</b>
C-020-750030		ICX-multi Abutment, straight, one piece GH 3mm	GH 3mm K 2.2mm	Titanium	<b>39*</b>

**Note:** L = Height from implant shoulder    GH = Gingiva height    K = Length of the stump starting from preparation margin

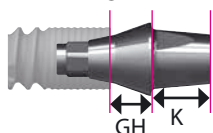

 Including connection screw  
(connection to the implant)

# Overview: The ICX-multi® products

## Required height 5.5mm

Article-Nr.		Article	Dimensions	Material	Price €
C-003-000005		ICX-multi protection cap	Ø 4.8 L 4.6mm	Titanium	19*
C-005-070001		ICX-multi impression post closed, casting cap included, connection screw included	L 11mm	Titanium	29*
C-005-070002		ICX-multi impression post open, connection screw included plus casting aid	L 13mm	Titanium	29*
C-006-010007		ICX-multi model analog short, CAD/CAM	L 11mm K 2.2mm	Titanium	19*
C-020-951120		ICX-multi prosthetic abutment, titanium	Ø 4.8 L 12mm (shortened to 4.1mm)	Titanium	39*
C-020-952120		ICX-multi prosthetic abutment, plastic	Ø 4,8 L 12mm (shortened to 4.1mm)	Plastic burn-out	19*
C-020-953120		ICX-multi interim/bite registration, peek	Ø 4,8 L 12mm (shortened to 4.1mm)	peek	19*
C-029-002010		ICX-multi adhesive base (for bar and plastic-resin veneered bridge)	Ø 4.8 L 5.5mm	Titanium	39*
C-029-002011		ICX-multi adhesive base 0mm, low preparation height	Ø 5.4mm, L 5.5mm	Titanium	39*
C-030-000010		ICX-multi scan base	L 12.5mm B 4.5mm T 6.5mm	Peek	39*
C-031-100001		ICX-Maximus, 1mm for ICX-multi	Ø 4.8 L 4,4mm	Titanium	39*
C-015-100030		ICX-Hex tool <b>SW 1.2 medium</b> for all screws of the abutments	SW 1.2mm	Stainless steel	49*
C-020-000001		ICX-multi tool <b>SW 3.2</b> for straight abutments	SW 3.2mm	Stainless steel	49*



Including prosthetic screw (connection to the abutment)

### Application and indication

The ICX-multi-concept is a prosthetic concept for immediate restoration of edentulous patients.





For better support of temporary restoration it is possible that the posterior implants are placed in 17° or 35° distal inclination.

This angulation is then compensated by the special abutments.

# Overview:

## The ICX-multi® products

### Required height 5.5mm

Article-No.		Dimensions	Material	*Price €	
C-020-956120	ICX- <i>multi</i> prosthetic abutment CrCo tightening torque = 27 Ncm Application: castable with non-precious alloys ICX- <i>multi</i> prosthetic abutment	Ø 4.8mm L 7mm	CoCr Biodur CCM/BC	49*	
C-020-750000	ICX- <i>multi</i> abutment straight 0mm Titanium (not ICX- <i>plus</i> ) tightening torque = 30 Ncm with driver C-020-000001 <b>Not for ICX-<i>plus</i> implants!</b>	Ø 4.8mm GH 0mm K 2.2mm	Titanium	39*	
C-020-750001	ICX- <i>multi</i> abutment straight <b>for ICX-<i>plus</i>,</b> 0mm	Ø 4.8mm GH 0mm K 2.2mm	Titanium	39*	
C-020-955120	ICX- <i>multi</i> welding abutment <b>Application:</b> Tightening torque = 27Ncm This abutment serves to weld several abutments with a wire	Ø 4.8mm L 12mm	Titanium	39*	
C-020-955121	ICX- <i>multi</i> welding abutment <b>Application:</b> Tightening torque = 27Ncm This abutment serves to weld several abutments with a wire	Ø 5.1mm L 10.5mm	Titanium	39*	



Including prosthetic screw  
(connection to the abutment)

### Application and indication

The ICX-*multi*-concept is a prosthetic concept for immediate restoration of edentulous patients.

For better support of temporary restoration it is possible that the posterior implants are placed in 17° or 35° distal inclination. This angulation is then compensated by the special abutments.



# ICX

The FAIR Implant-System





**Order in our ICX shop online at:  
[www.medentis.de](http://www.medentis.de)**

*ICX Opens  
New Horizons!*



**ICX**

The FAIR Implant-System

# ICX-multi<sup>®</sup> CONCEPT MANUAL 1.0

**4-ON-ICX (MANDIBLE)**  
**3 to 8 unit implant supported bridges  
and whole jaw solutions**  
**6-ON-ICX (MAXILLA)**

*ICX Opens  
New Horizons!*

The logo for ICX, consisting of the letters 'I', 'C', and 'X' in a bold, blue, sans-serif font. The 'I' and 'X' are a lighter blue, while the 'C' is a darker blue. The letters are set against a background of various dental implant components, including a long threaded rod, several conical abutments, and a hexagonal connector, all rendered in a light, semi-transparent style. The components are arranged in a way that suggests a complete implant system.

**ICX**

*The FAIR Implant-System*